

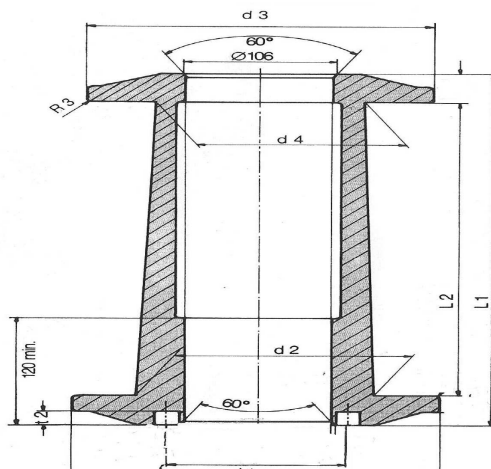

PLASTIC CONICAL SPOOL - 200 KG



Load: about 200 Kg

Outside- \varnothing = 400

Inside- \varnothing = 100

Height = 630

(unit of measurement = mm)